

The economic pressure transmitter ECT-8473 is based on the tried and true ECT line of transmitter with the wide media temperature range from -25 to 125°C. The enhanced accuracy and the low pressure ranges down to 100 mbar in combination with a comprehensive set of features, materials and options makes the ECT 8473 pressure transmitter an ideal and versatile solution suitable for a wide variety of applications.

**ECT-8473**



**Applications**

- Machine tools
- Hydraulics
- Water treatment

**Features**

- Economical
- Good media compatibility
- Relative or absolute pressure measurement
- Titanium version optional
- Frontal membrane optional

**TD301**



**SANITARY DIAPHRAGM SEAL**

AISI 316 / 316L, max 40 bar Tri-Clover

**TD302**

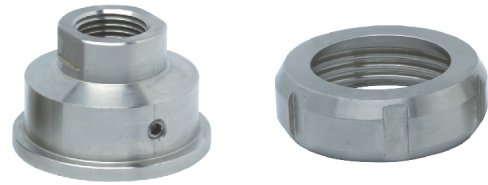

**SANITARY DIAPHRAGM SEAL**

WITH UNION NUT, AISI 316 / 316L, max 40 bar

Technical Data			
Measuring principle	Thick film on ceramic	Accuracy @ 25°C typ.	± 0.3 % FS typ. (± 0.5 % FS typ., ± 1 % FS typ.)
Measuring range	0 ... 0.1 to 0 ... 40 bar 0 ... 1.5 to 0 ... 500 psi	Media temperature	-25°C ... +125°C
Output signal	4 ... 20 mA, 0 ... 5 VDC, 1 ... 6 VDC, 0 ... 10 VDC, 0.5 ... 4.5 VDC ratiom.	Ambient temperature	-25°C ... +85°C Cable PVC 22: -5°C ... +60°C Cable PUR 24: -20°C ... +70°C Cable Raychem 08: -20°C ... +100°C

**Ordering information/type code**

Measuring range <sup>1)</sup>	Pressure measurement range [bar]	Over pressure [bar]	Burst pressure [bar]		Pressure measurement range [psi]	Over pressure [psi]	Burst pressure [psi]		8473 .	XX	XX	XX	XX	XX
	0 ... 0.1	1.2	2	<b>66</b>	0 ... 1.5	15	30	<b>F6</b>						
	0 ... 0.16	1.2	2	<b>67</b>	0 ... 2	15	30	<b>F7</b>						
	0 ... 0.2	1.2	2	<b>68</b>	0 ... 2.5	15	30	<b>F8</b>						
	0 ... 0.4	1.2	2	<b>69</b>	0 ... 5	15	30	<b>F9</b>						
	0 ... 0.6	2	3	<b>70</b>	0 ... 7.5	30	45	<b>G0</b>						
	0 ... 1.0	2	3	<b>71</b>	0 ... 15	30	45	<b>G1</b>						
	0 ... 1.6	3.2	4.8	<b>73</b>	0 ... 20	40	60	<b>G3</b>						
	0 ... 2.5	5	7.5	<b>75</b>	0 ... 30	60	90	<b>G5</b>						
	0 ... 4	8	12	<b>76</b>	0 ... 50	100	150	<b>G6</b>						
	0 ... 6	12	15	<b>77</b>	0 ... 100	200	250	<b>G7</b>						
	0 ... 10	20	25	<b>78</b>	0 ... 150	300	375	<b>G8</b>						
	0 ... 16	32	40	<b>79</b>	0 ... 250	500	625	<b>G9</b>						
	0 ... 25	50	75	<b>80</b>	0 ... 400	800	1200	<b>H0</b>						
	0 ... 40	80	100	<b>81</b>	0 ... 500	1000	1250	<b>H1</b>						
<b>Sensor</b>	Relative pressure, Material pressure connection and housing: 1.4305 (AISI303)			<b>54</b>	Absolute pressure, Material pressure connection and housing: 1.4305 (AISI303) <sup>2) 3)</sup>									<b>84</b>
	Relative pressure, Material pressure connection and housing: 1.4404/1.4435 (AISI316L) <sup>2)</sup>			<b>56</b>	Absolute pressure, Material pressure connection and housing: 1.4404/1.4435 (AISI316L) <sup>2) 3)</sup>									<b>86</b>
	Relative pressure, Material pressure connection and housing: 1.4462 (AISI318LN) <sup>2)</sup>			<b>50</b>	Absolute pressure, Material pressure connection and housing: 1.4462 (AISI318LN) <sup>2) 3)</sup>									<b>80</b>
	Relative pressure, titanium grade 5 <sup>2)</sup>			<b>51</b>	Absolute pressure, titanium grade 5 <sup>2) 3)</sup>									
<b>Pressure connection</b>	G1/4" female													<b>10</b>
	G1/4" male													<b>17</b>
	G1/2" male DIN3852-A <sup>2)</sup>													<b>21</b>
	G1/2" male DIN3852-E <sup>2)</sup>													<b>41</b>
	1/4" NPT male, ANSI B1.20.1 <sup>2)</sup>													<b>30</b>
	1/8" NPT male, ANSI B1.20.1 <sup>10)</sup>													<b>43</b>
	7/16" -20UNF male SAE4 <sup>2) 8)</sup>													<b>42</b>
	R1/4" male, DIN3858													<b>19</b>
G3/4" frontal membrane <sup>2) 4)</sup>													<b>52</b>	
<b>Electrical connection</b>	Male electrical plug EN 175301-803-A, Mat. PA													<b>05</b>
	Male electrical plug M12x1, 5-pole, Mat. PA (Old shape), Mat. PBT (New shape)													<b>35</b>
	Male electrical plug industrial standard (contact distance 9.4 mm) Mat. PBT													<b>01</b>
	Male electrical plug Packard Metri Pack, Mat. PBT <sup>9)</sup>													<b>51</b>
	Cable PUR, cable gland PA 6-3, -20°C ... +70°C <sup>5) 4)</sup>													<b>24</b>
	Cable PVC, cable gland PA 6-3, -5°C ... +60°C <sup>5) 4) 9)</sup>													<b>22</b>
	Cable Raychem, cable gland PA 6-3, -20°C ... +100°C <sup>5) 4) 9)</sup>													<b>08</b>
Cable IP68, Mat. PVC, max. 3m, Medium +10°C ... +35°C, Pmax. 1 bar rel./abs. (old version)													<b>68</b>	
<b>Output signal</b>	<b>Signal output</b>	<b>Load resistance</b>	<b>I (supply)</b>	<b>U (supply)</b>										
	4 ... 20 mA	(U <sub>supply</sub> -9 V) / 20 mA		9 ... 30 VDC										<b>19</b>
	0 ... 5 VDC	≥ 2.5 kΩ	≤ 10 mA	10 ... 30 VDC										<b>14</b>
	1 ... 6 VDC	≥ 5.0 kΩ	≤ 10 mA	10 ... 30 VDC										<b>16</b>
	0 ... 10 VDC	≥ 5.0 kΩ	≤ 10 mA	15 ... 30 VDC										<b>17</b>
0.5 ... 4.5 VDC	≥ 5.0 kΩ	≤ 10 mA	5 VDC ± 0.25 VDC ratiom.										<b>23</b>	

8473 . XX XX XX XX XX XX

<b>Accessories</b>	Seal FKM (-20°C ... +125°C)	61
	Seal CR ≤ 100 bar (-25°C ... +100°C) <sup>7)</sup>	62
	Seal EPDM (-25°C ... +125°C)	63
	Pressure peak damping element ø 1.0 mm (for pressure connections 17 and 30)	40
	Pressure peak damping element ø 0.3 mm (for pressure connections 17 and 30)	43
	Pressure peak damping element ø 0.5 mm (for pressure connections 17 and 30)	45
	Female electrical connector EN 175301-803-A (DIN43650-A)	58
	Female electrical plug M12x1, 5-pole	33
	Female electrical connector industrial standard	34
	Special electrical connection: Pin 1 + , Pin 2 - (only for output signal 4 ... 20 mA and male electrical plug EN175301-803-A / DIN43650-A)	92
	Special electrical connection: Pin 1 Out, Pin 2 -, Pin 3 + (only for output 14, 16, 17, 23 and male electrical plug EN175301-803-A / DIN43650-A)	98
	Special electrical connection: Pin 1 + , Pin 2 -, Pin 3 Out (only for output signals 14, 16, 17, 23 and male electrical plug EN 175301-803-A / DIN 43650-A)	97
	Special electrical connection: Pin 1 + , Pin 3 - (only for output 4 ... 20 mA and male electrical plug Packard Metri Pack 3-poles)	E4
	Special electrical connection: Pin 1 + , Pin 2 Out Pin 3 - (only for output signals 14, 16, 17, 23 and male electrical plug Packard Metri Pack 3-poles)	99
	Cable length 1.5 m	1M
	Cable length 3.0 m	3M
	Cable length 5.0 m	5M
	Housing nut for electrical connection EN175301-803-A (DIN43650-A) secured with Loctite (max. 85°C)	L9

<sup>1)</sup> Extended overpressure as well as customized pressure ranges upon request

<sup>2)</sup> Please ask us

<sup>3)</sup> Only for ranges: ≥ 400 mbar or 5 psi

<sup>4)</sup> Not for sensors 54 and 84, only for pressure ranges ≤ 10 bar or 150 psi

<sup>5)</sup> Cable length see accessories (max. length 50 m, in 5-meter sections)

<sup>6)</sup> Protection IP68: Immersion depth max. 3 m, Media +10°C ... +35°C

<sup>7)</sup> Only for pressure connections 10 and 30

<sup>8)</sup> According to norm J1926, max. 35 MPa

<sup>9)</sup> Pressure ranges > 16 bar (Pressure ranges ≤ 16 bar upon request)

<sup>10)</sup> Only for sensors 56 and 86 and electrical connections 01, 35, 51 (others on request)



Identical construction for refrigeration:  
Data sheet No. H72323

### Standard products (extra short lead time)

Product No.	Type Code	Pressure range [bar]	Over pressure max. [bar]	Pressure connection	Signal output	Accuracy @ 25°C typ. [%]
ECT0.1A	8473 66 5417 05 0000 0000 19 58 61	0 ... 0.1	2	G1/4" male	4 ... 20 mA	1.0
ECT0.2A	8473 68 5417 05 0000 0000 19 58 61	0 ... 0.2	2	G1/4" male	4 ... 20 mA	0.5
ECT0.4A	8473 69 5417 05 0000 0000 19 58 61	0 ... 0.4	2	G1/4" male	4 ... 20 mA	0.5
ECT0.6A	8473 70 5417 05 0000 0000 19 58 61	0 ... 0.6	2	G1/4" male	4 ... 20 mA	0.3
ECT0.1V	8473 66 5417 05 0000 0000 17 58 61	0 ... 0.1	2	G1/4" male	0 ... 10 VDC	1.0
ECT0.2V	8473 68 5417 05 0000 0000 17 58 61	0 ... 0.2	2	G1/4" male	0 ... 10 VDC	0.5
ECT0.4V	8473 69 5417 05 0000 0000 17 58 61	0 ... 0.4	2	G1/4" male	0 ... 10 VDC	0.5
ECT0.6V	8473 70 5417 05 0000 0000 17 58 61	0 ... 0.6	2	G1/4" male	0 ... 10 VDC	0.3
ECTF0.1A	8473 66 5652 05 0000 0000 19 58 61	0 ... 0.1	2	G3/4" frontal membrane	4 ... 20 mA	1.0
ECTF0.2A	8473 68 5652 05 0000 0000 19 58 61	0 ... 0.2	2	G3/4" frontal membrane	4 ... 20 mA	0.5
ECTF0.4A	8473 69 5652 05 0000 0000 19 58 61	0 ... 0.4	2	G3/4" frontal membrane	4 ... 20 mA	0.5
ECTF0.6A	8473 70 5652 05 0000 0000 19 58 61	0 ... 0.6	2	G3/4" frontal membrane	4 ... 20 mA	0.3
ECTF1.0A	8473 71 5652 05 0000 0000 19 58 61	0 ... 1	2	G3/4" frontal membrane	4 ... 20 mA	0.3
ECTF1.6A	8473 73 5652 05 0000 0000 19 58 61	0 ... 1.6	3.2	G3/4" frontal membrane	4 ... 20 mA	0.3
ECTF2.5A	8473 75 5652 05 0000 0000 19 58 61	0 ... 2.5	5	G3/4" frontal membrane	4 ... 20 mA	0.3
ECTF4.0A	8473 76 5652 05 0000 0000 19 58 61	0 ... 4	8	G3/4" frontal membrane	4 ... 20 mA	0.3
ECTF6.0A	8473 77 5652 05 0000 0000 19 58 61	0 ... 6	12	G3/4" frontal membrane	4 ... 20 mA	0.3
ECTF10.0A	8473 78 5652 05 0000 0000 19 58 61	0 ... 10	20	G3/4" frontal membrane	4 ... 20 mA	0.3

Specifications		
<b>Electrical Data</b>	Output / supply voltage	4 ... 20 mA: 24 (9 ... 30) VDC 0 ... 5 VDC: 24 (10 ... 30) VDC 1 ... 6 VDC: 24 (10 ... 30) VDC 0 ... 10 VDC: 24 (15 ... 30) VDC 0.5 ... 4.5 VDC: 5 VDC ratiom.
	Rise time	Typ. 1 ms / 10 ... 90 % nominal pressure
	Switch-on-delay	Max. 1.5 s
	Inverse-polarity protection, short-circuit strenght @ 25°C during 5 min.	4...20 mA: to $U_s = 30$ VDC 0...10 VDC, 0...5 VDC, 1...6 VDC: to $U_s = 30$ VDC 0.5...4.5 VDC ratiometric: to $U_s = 5.25$ VDC
	<b>Environmental conditions</b>	Media temperature
	Ambient temperature	-25°C ... +85°C Cable PVC 22: -5°C ... +60°C Cable PUR 24: -20°C ... +70°C Cable Raychem 08: -20°C ... +100°C
	Protection <sup>1)</sup>	IP65, IP67, IP68
	Humidity	Max. 95 % relative
	Vibration	4 g (10...2000 Hz)
	Shock	50 g / 8 ms
<b>EMC Protection</b>	Emission	EN/IEC 61000-6-3
	Immunity	EN/IEC 61000-6-2
<b>Mechanical Data</b>	Sensor (wetted parts)	Ceramic, Al <sub>2</sub> O <sub>3</sub> (96 %)
	Pressure connection (wetted parts)	54/84: 1.4305 (AISI303) 56/86: 1.4404/1.4435 (AISI316L) 50/80: 1.4462 (AISI318LN) 51/81: Titanium Grade 5
	Housing	54/84: 1.4305 (AISI303) 56/86: 1.4404/1.4435 (AISI316L) 50/80: 1.4462 (AISI318LN) 51/81: Titanium Grade 5
	Sealing	FKM 70 Sh, CR, EPDM
	Male electrical plug	See ordering information
	Weight	~ 110 g
	Mounting torque	15 ... 20 Nm

<sup>1)</sup> See electrical connection

Accuracy				
Pressure measuring range	[bar]	> 0 ... 0.4	0 ... 0.2	0 ... 0.1
	[psi]	> 0 ... 5	0 ... 0.4	0 ... 0.16
			0 ... 2.5 <td>0 ... 1.5</td>	0 ... 1.5
			0 ... 5 <td>0 ... 2</td>	0 ... 2
TEB @ -25 ... +85°C	[% FS typ.]	± 1.0	± 2.0	± 3.0
Accuracy @ +25°C	[% FS typ.]	± 0.3	± 0.5	± 1.0
NLH @ +25°C (BSL)	[% FS typ.]	± 0.2	± 0.3	± 0.3
TC zero point and span	[% FS/K typ.]	± 0.02	± 0.02	± 0.02
Long term stability 1 year @ +25°C	[% FS typ.]	± 0.2	± 0.2	± 0.2

### Measuring accuracy 1.0 %

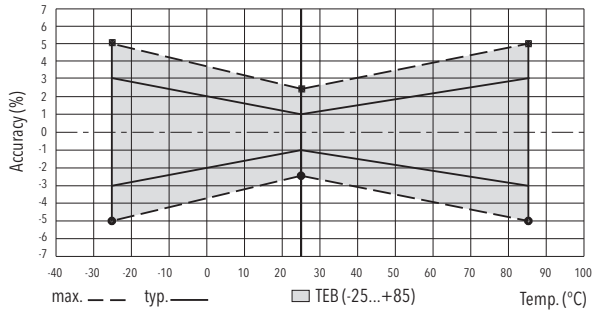

### Measuring accuracy 0.5 %

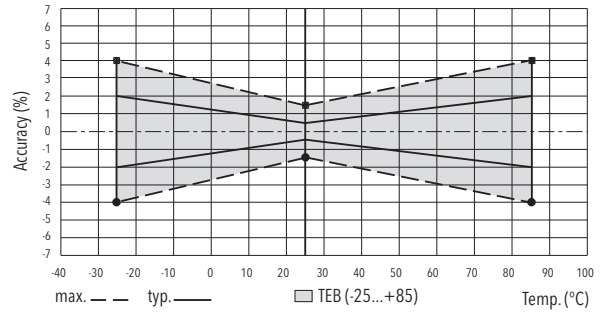

### Measuring accuracy 0.3 %

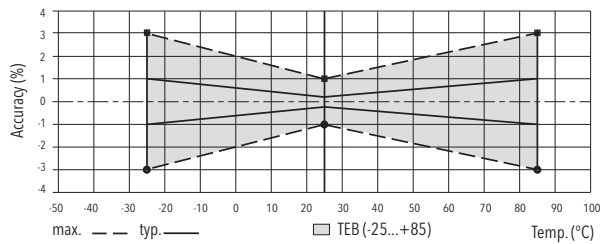

### Electrical connection

		Protection / electrical connection						
		IP65*)	IP67*)	IP67*)	IP65	IP67/IP68 max. 3m	IP68 max. 3m	
		Industrial standard EN175301-803A **)	M12x1 **) 5-pole	Packard Metri Pack **) 3-pole	Industrial standard Contact distance 9.4 mm **)	Cable **)	Cable **)	
		<b>05</b>	<b>35</b>	<b>51</b>	<b>01</b>	<b>24/22/68</b>	<b>08</b>	
Output signal	<p><b>8473.xx.xxxx.xx.19</b></p>	Standard	<b>92</b>		<b>E4</b>			
	<p><b>8473.xx.xxxx.xx.14/16/17/23</b></p>	Standard	<b>98</b>	<b>97</b>	<b>99</b>			
		2 1 ⊕	1 2 ⊕	4 1 5	1 2 3	2 1 ⊕	white brown yellow	red black green
		2 3 1 ⊕	3 1 2 ⊕	2 3 2 5	1 3 2 3	1 2 3 ⊕	white green brown yellow	red white black green

\*) Provided female connector is mounted according to instructions  
 \*\*) Ventilation via male electric plug/cable end  
 \*\*\*) Only cable versions or female electrical plug with shield connection

**Dimensions**

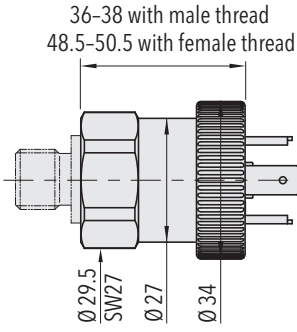

8473.XX.XXXX.05.XX.XX

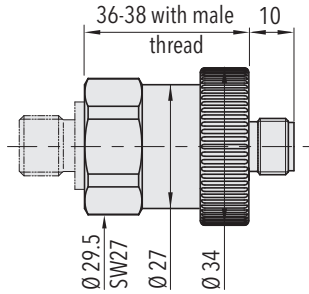

8473.XX.XXXX.35.XX.XX Old shape

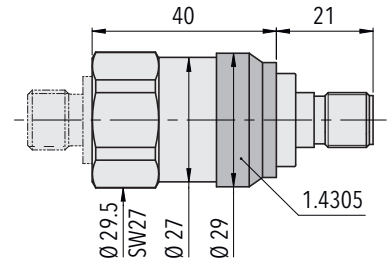

8473.XX.XXXX.35.XX.XX New shape

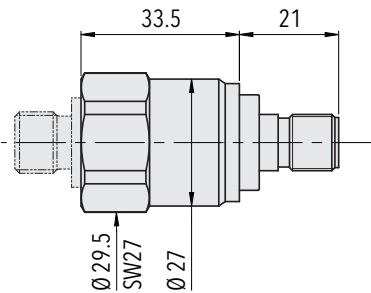

8473.XX.X717.35.XX.XX

8473.XX.X942.35.XX.XX

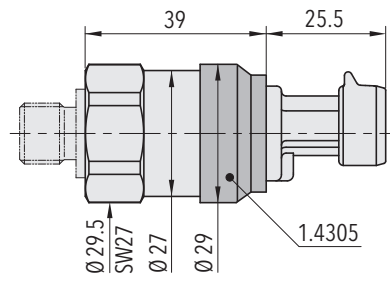

8473.XX.XXXX.51.XX.XX

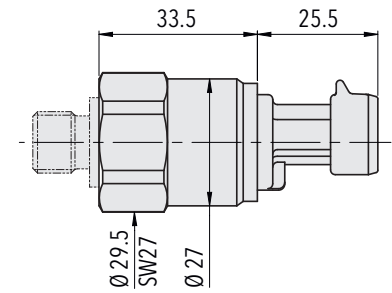

8473.XX.X717.51.XX.XX

8473.XX.X942.51.XX.XX

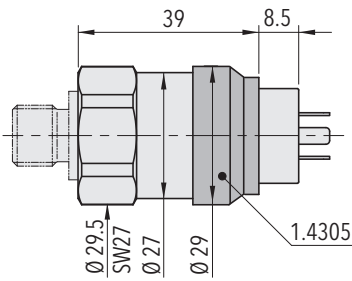

8473.XX.XXXX.01.XX.XX

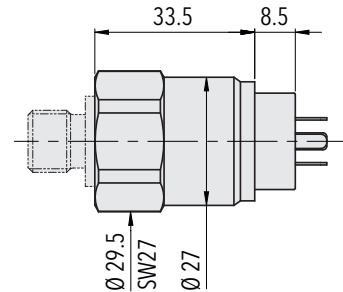

8473.XX.X717.01.XX.XX

8473.XX.X942.01.XX.XX

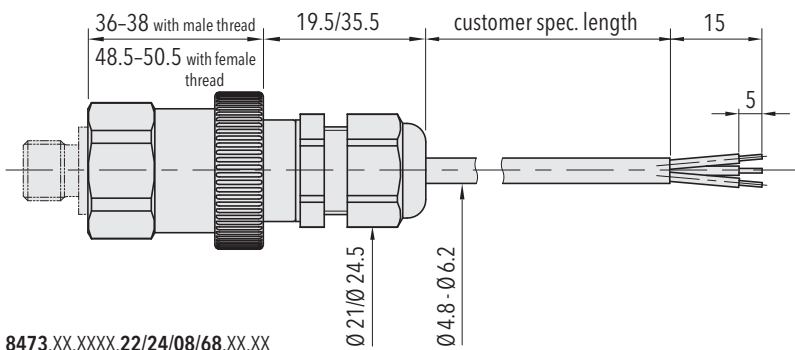

8473.XX.XXXX.22/24/08/68.XX.XX

**Dimensions**

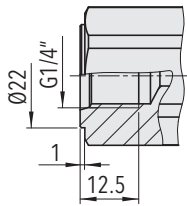

8473.XX.XX10.XX.XX.XX

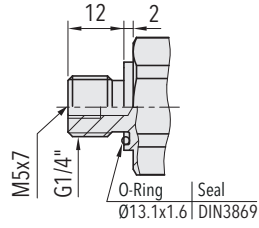

8473.XX.XX17.XX.XX.XX

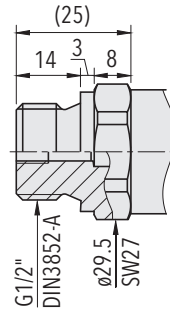

8473.XX.XX21.XX.XX.XX

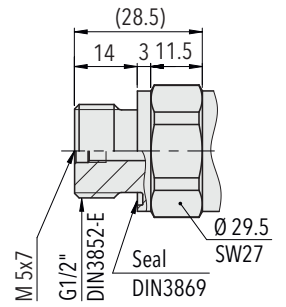

8473.XX.XX41.XX.XX.XX

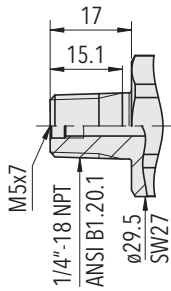

8473.XX.XX30.XX.XX.XX

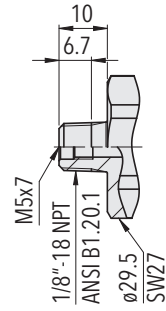

8473.XX.X643.XX.XX.XX

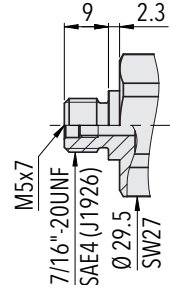

8473.XX.XX42.XX.XX.XX

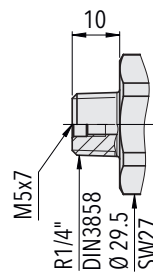

8473.XX.XX19.XX.XX.XX

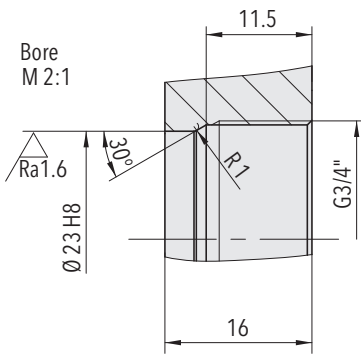

8473.XX.XX52.XX.XX.XX

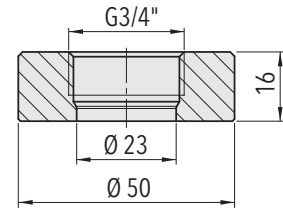
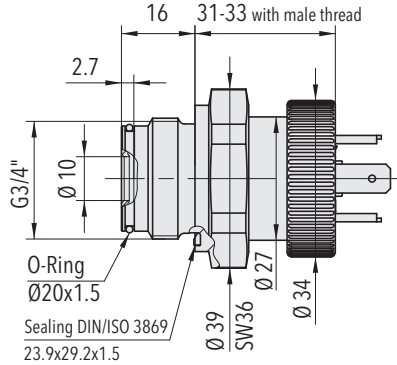

Welding flange for G3/4" frontal membrane (1.4301)  
Ordering No. C27805

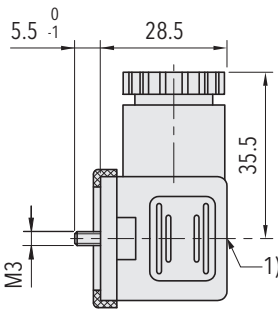

1) Tightening torque 50...60Ncm

8473.XX.XXXX.XX.XX.58

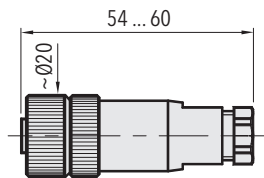

8473.XX.XXXX.XX.XX.33

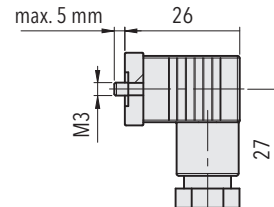

8473.XX.XXXX.XX.XX.34